

8-channel LCD & Camera EMI Filter with ESD Protection Chip Scale Packaging (CSP)

Features

- Eight (8) Low pass EMI filters with excellent attenuation at high frequencies
- ESD protection at 15KV per IEC61000
- 20-bump CSP device (4.000mm x 1.458mm)
- Polymer back coating to improve mechanical strength
- RoHS Compliant in Lead-Free Versions

Applications

- Cellular Handsets
- PDA
- MP3 Players
- PC & Notebooks
- Smart Cards
- Digital Cameras

Product Description

The EMF4020-08CR is an 8-channel pi-style Capacitor-Resistor-Capacitor EMI/RFI Filter with integrated Diodes for electrostatic discharge (ESD) protection. This device offers greater than 30dB attenuation in the 800MHz to 3GHz. The diodes provide a 15kV contact-discharge ESD protection per IEC-61000 specifications.

The device is built in a 20-bump CSP format with 0.5mm pitch and is ideal for portable electronic systems.

Schematic for Each Line

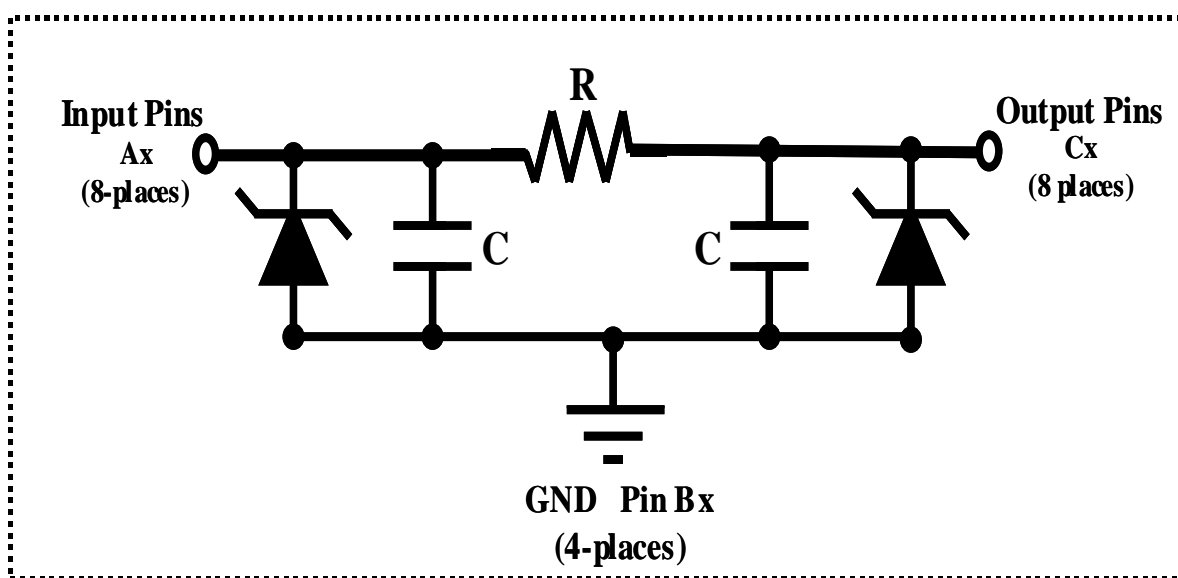

ELECTRICAL OPERATING CHARACTERISTICS (Note: 1)						
SYMBOL	PARAMETERS	CONDITIONS	MIN	TYP	MAX	UNITS
R	Resistance		80	100	120	Ω
C	Capacitance	@ 2.5V DC, 1MHz, 30mV AC	12	15	18	pF
V _{DIODE}	Diode Standoff Voltage	I _{DIODE} = 10 μ A		6		V
V _{LEAK}	Diode Leakage Current (Reverse Bias)	V _{DIODE} = 3.3V		100	200	nA
V _{SIG}	Signal Voltage:	I _{LOAD} = 10mA				
	Positive		5.6	6.8	9	V
	Negative		-1.5	-0.8	-0.4	V
V _{ESD}	ESD Protection: (a) Human Body Model, MIL-STB-883, Method 3015 (b) Contact discharge per IEC 61000-4- 2 Level 4 standards	(Note: 2 & 3)				
			\pm 30			kV
			\pm 15			kV
V _{DYN}	Dynamic Resistance:					
	Positive			2.3		Ω
	Negative			0.9		Ω
f _c	Cut-off Frequency: Z _{SOURCE} = 50 Ω ; Z _{LOAD} = 50 Ω	R = 100 Ω ; C = 15pF		120		MHz
T	Temperature Range:					
	Operating		-40		85	$^{\circ}$ C
	Storage		-55		150	$^{\circ}$ C

Notes:

1. Parameters at Ambient Temperature (TA) of 25 $^{\circ}$ C unless otherwise specified
2. ESD applied to input and output pins with respect to Ground, one pin at a time
3. Parameters are guaranteed by design and characterization

ORDERING PART NUMBER					
PART NUMBER	NUMBER OF CHANNLES	PACKAGE TYPE	DEVICE MARKING	T & R Qty	ROHS COMPLIANCE
EMF4020-08 CR	8	CSP-20	EMF4020	3,500/Reel	YES

Figure 1: Typical Insertion Loss Curve

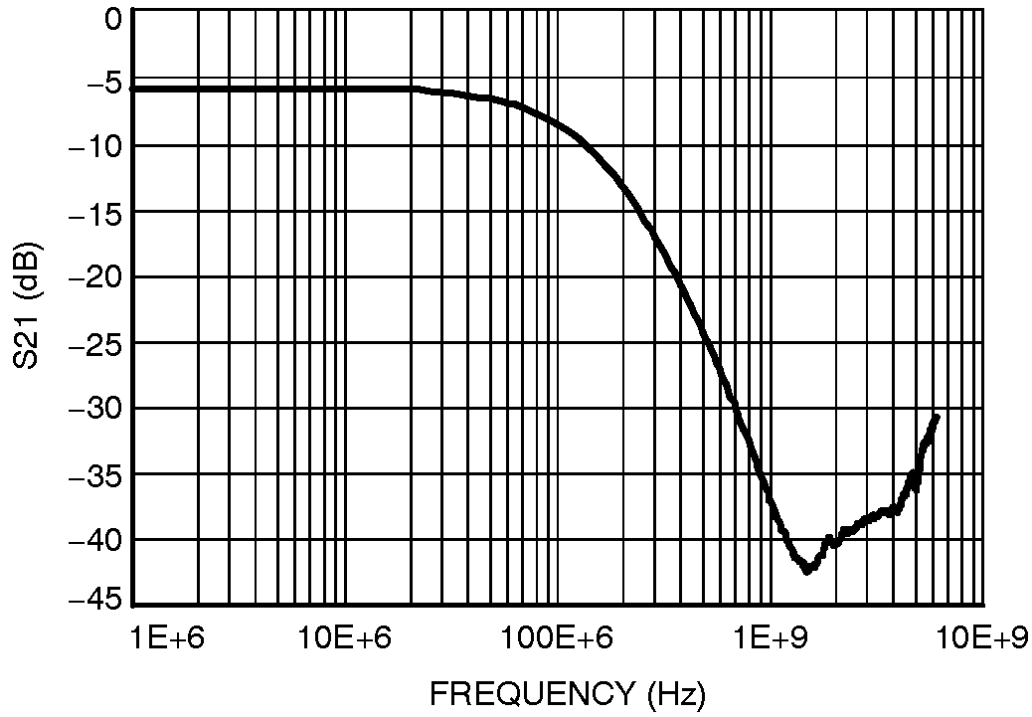

FIGURE 2
RESISTANCE VS TEMPERATURE
(Normalized to Resistance at 25°C)

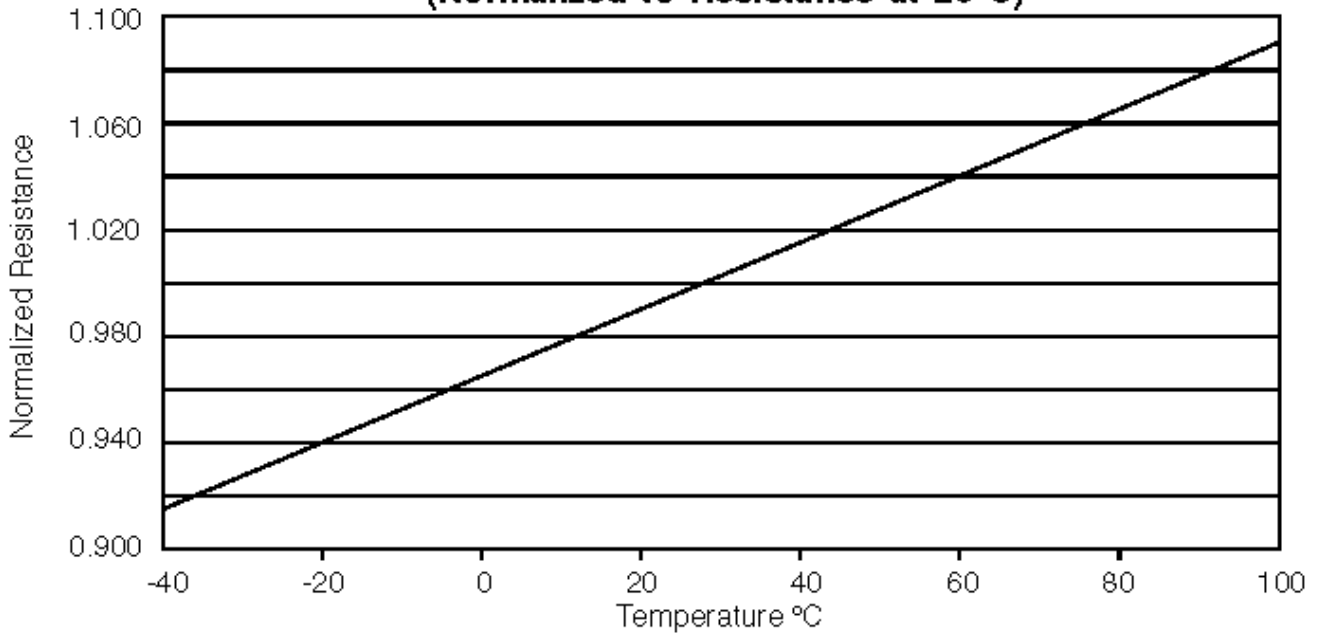
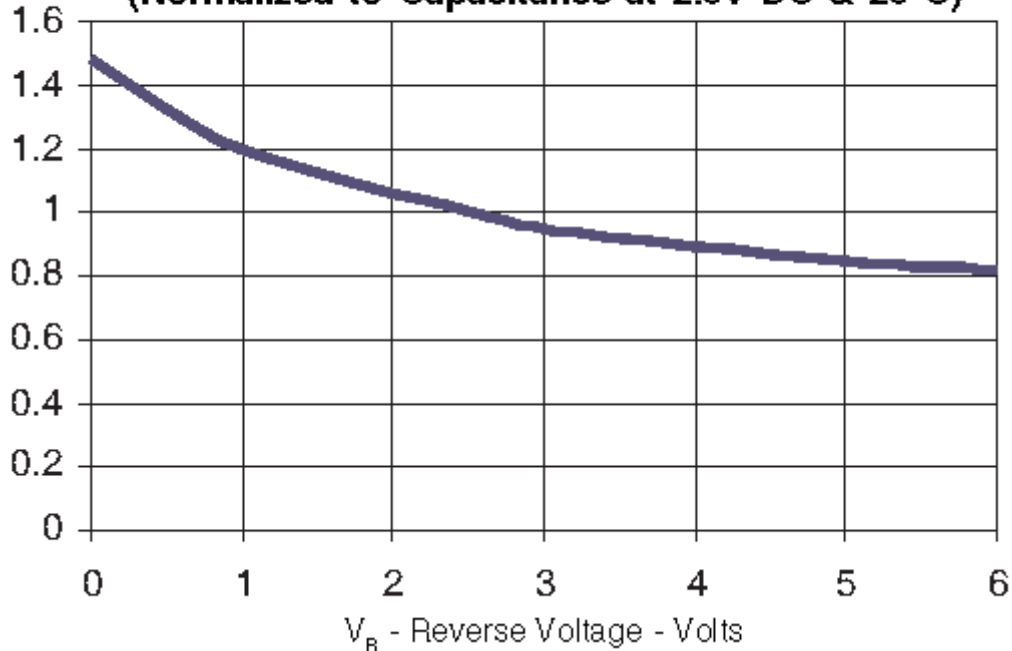

FIGURE 3
CAPACITANCE VS REVERSE VOLTAGE
(Normalized to Capacitance at 2.5V DC & 25°C)



Application Information

PRINTED CIRCUIT BOARD RECOMMENDATIONS	
PARAMETER	VALUE
Pad Size on PCB	0.275mm
Pad Shape	Round
Pad Definition	Non-Solder Mask defined pads
Solder Mask Opening	0.325mm Round
Solder Stencil Thickness	0.125mm - 0.150mm
Solder Stencil Aperture Opening (laser cut, 5% tapered walls)	0.330mm Round
Solder Flux Ratio	50/50 by volume
Solder Paste Type	No Clean
Pad Protective Finish	OSP (Entek Cu Plus 106A)
Tolerance — Edge To Corner Ball	+50µm
Solder Ball Side Coplanarity	+20µm
Maximum Dwell Time Above Liquidous ⁶	0 seconds
Maximum Soldering Temperature	260°C

**Lead Free (SnAgCu) Solder
Ball Reflow Profile**

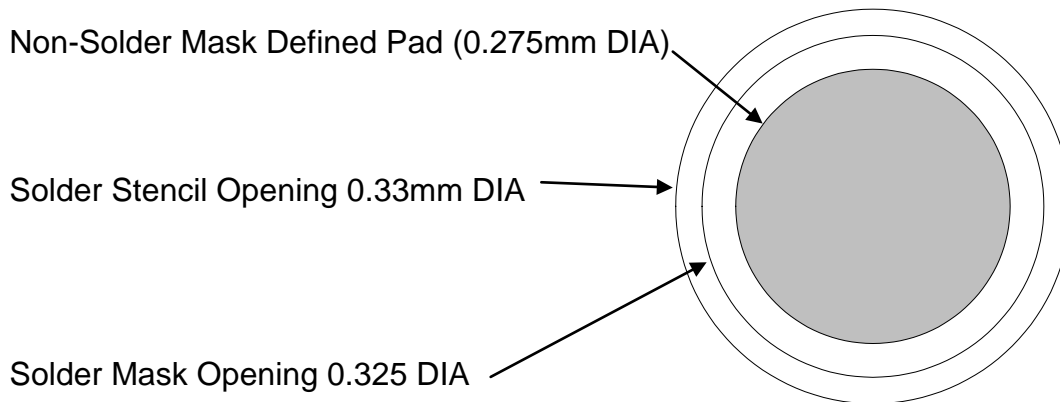
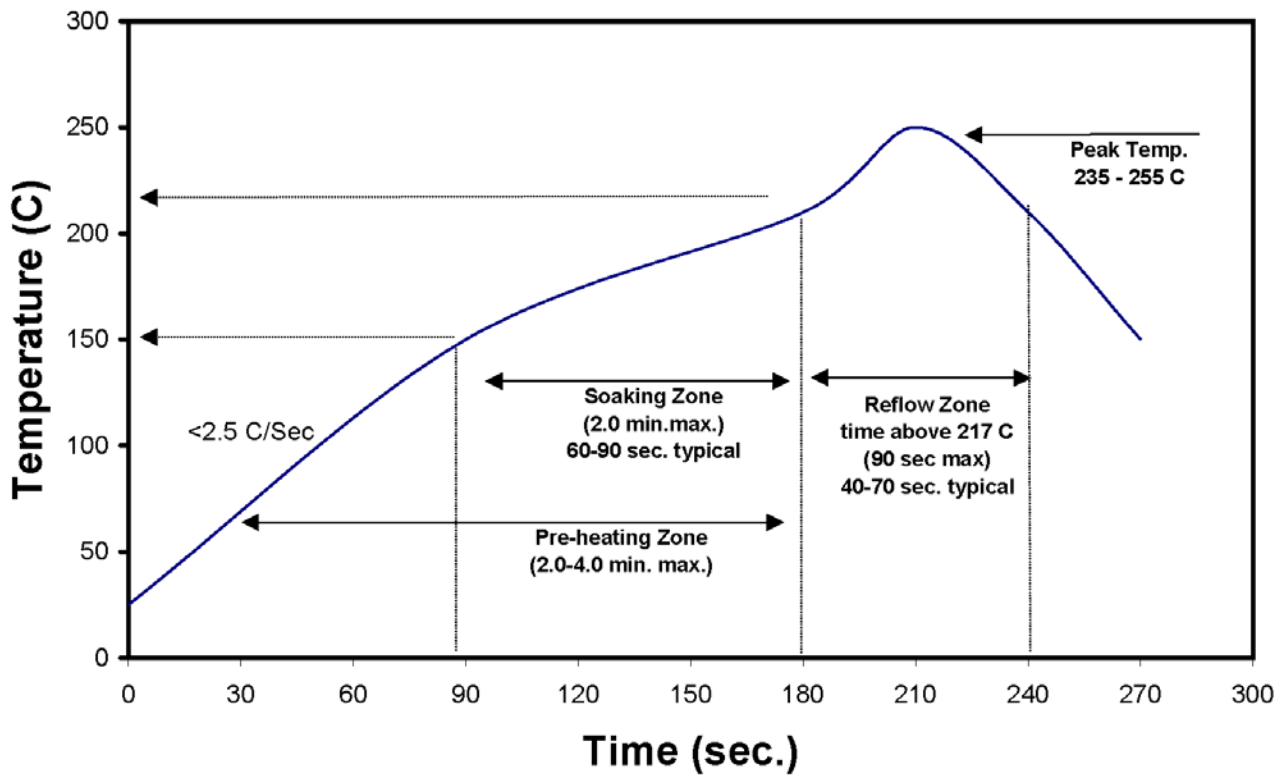

Mechanical Package Diagram

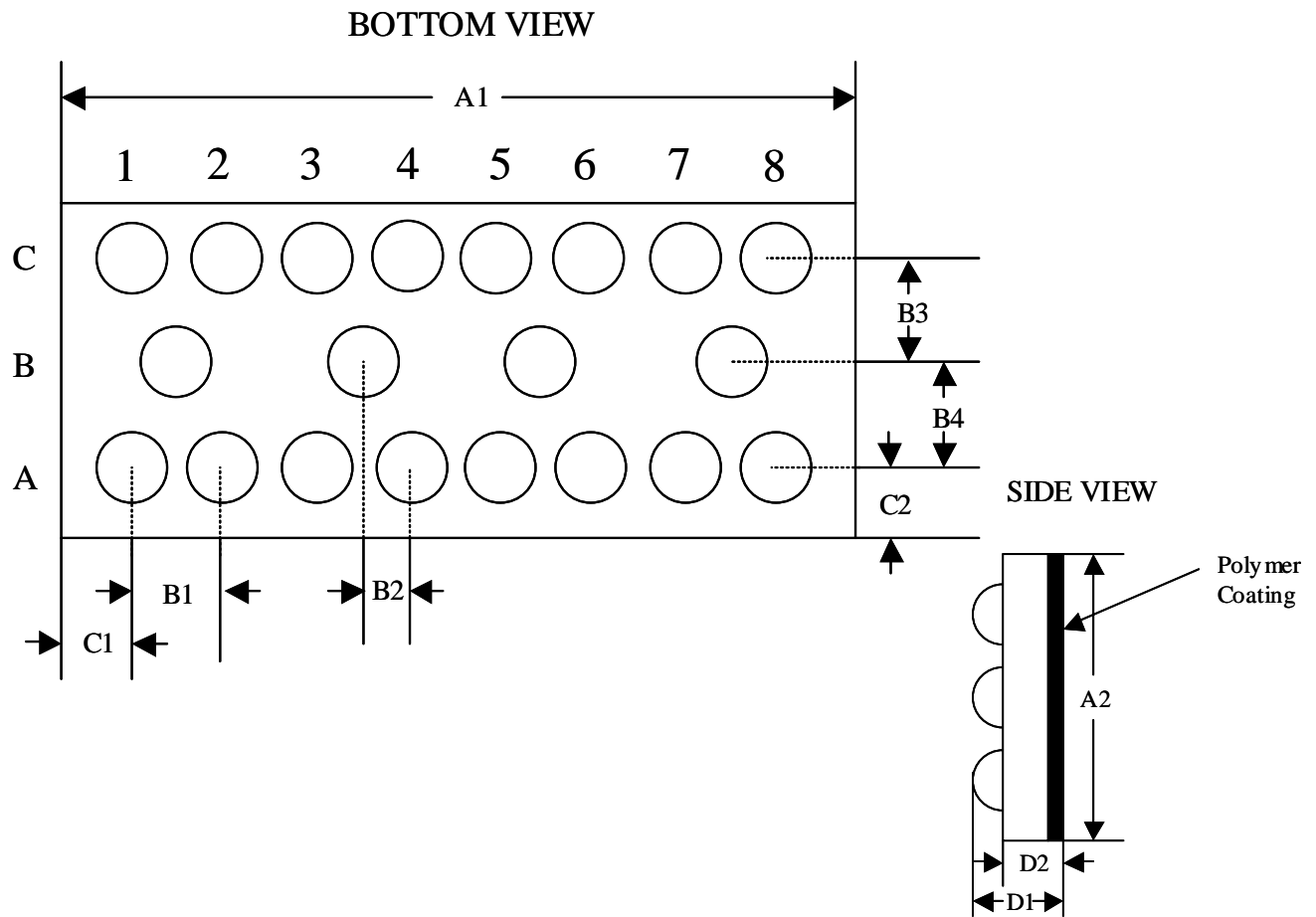

Package Dimensions						
Dimensions	Millimeters (mm)			Inches (")		
	Min.	Typ.	Max.	Min.	Typ.	Max.
A1	3.955	4.000	4.045	0.1557	0.1575	0.1493
A2	1.413	1.458	1.503	0.0556	0.0574	0.0592
B1	0.495	0.500	0.505	0.0195	0.0197	0.0199
B2	0.245	0.250	0.255	0.0096	0.0098	0.0100
B3	0.430	0.435	0.440	0.0169	0.0171	0.0173
B4	0.430	0.435	0.440	0.0169	0.0171	0.0173
C1	0.200	0.250	0.300	0.0079	0.0098	0.0118
C2	0.244	0.296	0.344	0.0096	0.0116	0.0135
D1	0.575	0.644	0.714	0.0226	0.0254	0.0281
D2	0.368	0.419	0.470	0.0145	0.0165	0.0185
Parts/reel	3,500					
Controlling Dimension: mm						